



**VAN CARE**



**VAN RACKING**  
**OPEL**

# ABOUT US

Van Care has been a manufacturer in the field of commercial vehicle Van Racking Kits for many years. Our head office is located in Beek, The Netherlands, and our team consists of four employees. The production site is based in Poland, and has 100 employees.

Van Care offers a suitable solution for every commercial vehicle. We work with lightweight modular equipment and provide tailor-made solutions. The modular construction allows you to put together your ideal interior with the exact shelves, drawers and spaces you need.

## OUR OFFER

VAN RACKING SYSTEMS



Thanks to an extensive network of specialized dealers, we can deliver fully customized Van Racking. Kits tailored specifically to your needs. Feel free to contact us for more information and an introductory conversation.

## VAN CARE PRODUCTS

Van Care products are innovative, lightweight and durable. All products are made of ultra-high strength materials, resulting in minimal weight and maximum loading capacity.



THE BEST  
QUALITY



FREE  
CONSULTANCY



COST  
REDUCTION

## SAFETY

All Van Care's Van Racking Kits are tested extensively. Crash tests are continuously being carried out at specialized research centers.

Simulation, load capacity and vibration tests are continuously researched and performed.

Time and time again our products have proven to be extremely safe. Take these results from one of our frontal impact tests for example.



The speed of the crash test was increased from 32km/h to 50km/h. According to the report, the material had been deformed, but without creating dangerous situations for the passengers due to the loosening of parts.

# SAFETY & QUALITY

ARE OUR MAIN GOALS

## PROVEN QUALITY OF OUR PRODUCTS

Van Care guarantees optimal safety, today and in the future. Everything is made for functional use and safety during work and transport. The production is fully certified and complies to ISO 9001:2015 and TÜV requirements.

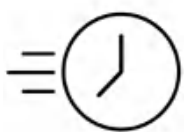

TIME  
SAVING



PERSONALIZED  
PROJECT



GREAT  
TESTS RESULTS





# CONTENT LIST:

## COMBO

### MODULES:

WHEEL BASE:2785mm 6-7

WHEEL BASE:2975mm 8-9

### XLD LINE:

WHEEL BASE:2785mm 10

WHEEL BASE:2975mm 11

## VIVARO

### MODULES:

WHEEL BASE:2925mm 12-13

WHEEL BASE:3275mm 14-15

### XLD LINE:

WHEEL BASE:2925mm 16

WHEEL BASE:3275mm 17

## MOVANO

### MODULES:

WHEEL BASE:3000mm 18-19

WHEEL BASE:3450mm 20-21

WHEEL BASE:4035mm 22-23

WHEEL BASE:4035mm MAXI 24-25



Length



Height



Depth



Weight

# COMBO



# VAN CARE

LEFT SIDE

Bronze Line

57-1-100-00



(wheel base: 2785mm)

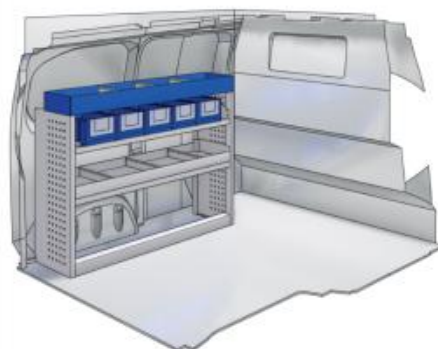

L 1267mm H 980mm D 360mm 40kg

Silver Line

57-1-102-00



(wheel base: 2785mm)



L 1267mm H 980mm D 360mm 37kg

Gold Line

57-1-104-00



(wheel base: 2785mm)



L 1267mm H 980mm D 360mm 60kg



**VAN CARE**



**COMBO**

57-1-101-00

Bronze Line

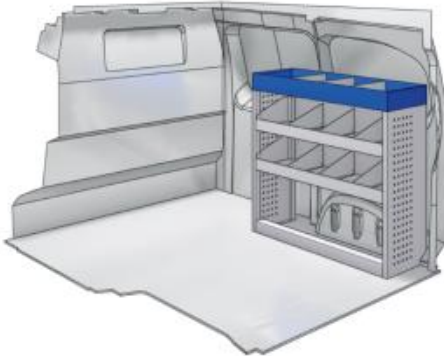

(wheel base: 2785mm)

**L** 1014mm **D** 980mm **D** 360mm **8** 21kg

RIGHT SIDE

57-1-103-00

Silver Line



(wheel base: 2785mm)

**L** 1014mm **D** 980mm **D** 360mm **8** 35kg

57-1-150-00

Gold Line



(wheel base: 2785mm)

**L** 1014mm **D** 1085mm **D** 360mm **8** 56kg



# COMBO



# VAN CARE

LEFT SIDE

Bronze Line

57-1-106-00



(wheel base: 2975mm)

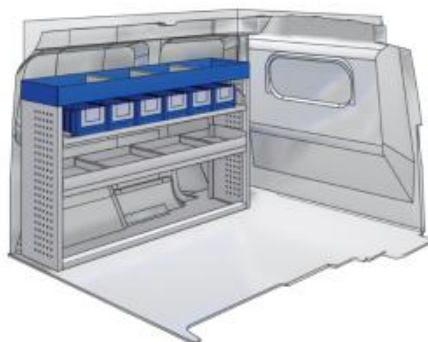

 1521mm  980mm  360mm  45kg

Silver Line

57-1-107-00



(wheel base: 2975mm)



 1521mm  980mm  360mm  45kg

Gold Line

57-1-108-00



(wheel base: 2975mm)

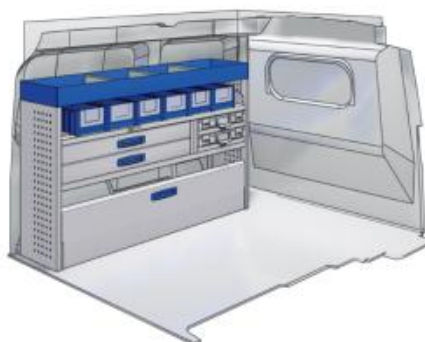

 1521mm  980mm  360mm  68kg





**VAN CARE**



**COMBO**

57-1-101-00

Bronze Line

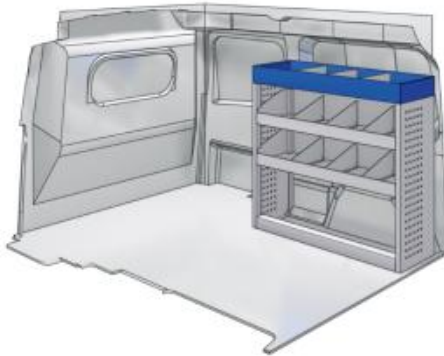

RIGHT SIDE

**L** 1014mm **D** 980mm **D** 360mm **8** 21kg

(wheel base: 2975mm)

57-1-103-00

Silver Line



**L** 1014mm **D** 980mm **D** 360mm **8** 35kg

(wheel base: 2975mm)

57-1-151-00

Gold Line



**L** 1014mm **D** 1085mm **D** 360mm **8** 60kg

(wheel base: 2975mm)

# COMBO



# VAN CARE

XLD LINE

Bronze Line

57-1-155-00



(wheel base: 2785mm)

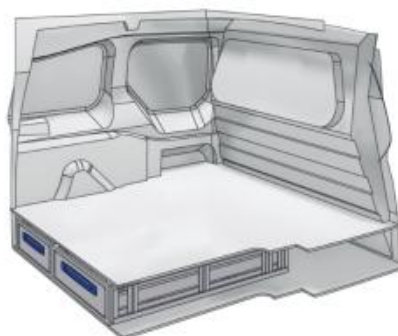

L 1026mm H 176mm D 1075mm W 41kg

Silver Line

57-1-109-00



(wheel base: 2785mm)



L 1492mm H 176mm D 1270mm W 62kg

Gold Line

57-1-110-00



(wheel base: 2785mm)

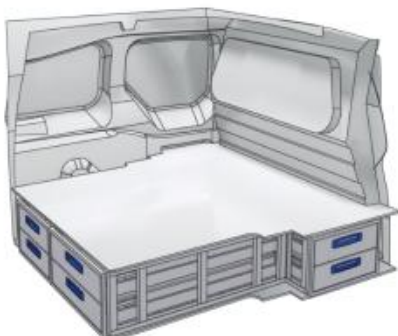

L 1492mm H 310mm D 1270mm W 111kg



VAN CARE



COMBO

57-1-156-00

Bronze Line



(wheel base: 2975mm)

 1266mm  176mm  1075mm  44kg

57-1-148-00

Silver Line

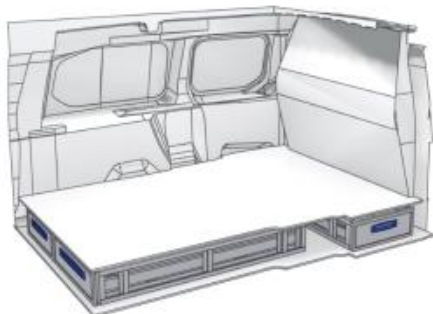

(wheel base: 2975mm)

 1732mm  176mm  1266mm  65kg

57-1-113-00

Gold Line



(wheel base: 2975mm)

 1732mm  310mm  360mm  120kg



# VIVARO



## VAN CARE

LEFT SIDE

Bronze Line

57-1-115-00



(wheel base: 2925mm)



 1774mm  1260mm  360mm  50kg

Silver Line

57-1-117-00



(wheel base: 2925mm)



 1774mm  1225mm  360mm  63kg

Gold Line

57-1-119-00



(wheel base: 2925mm)



 1774mm  1260mm  360mm  74kg



**VAN CARE**



**VIVARO**

57-1-116-00

Bronze Line



RIGHT SIDE

**L** 1014mm **D** 1085mm **D** 360mm **8** 40kg

(wheel base: 2925mm)

57-1-118-00



**L** 1014mm **D** 1085mm **D** 360mm **8** 55kg

(wheel base: 2925mm)

57-1-105-00



**L** 1267mm **D** 1085mm **D** 360mm **8** 63kg

(wheel base: 2925mm)



LEFT SIDE

Bronze Line

57-1-120-00



(wheel base: 3275mm)

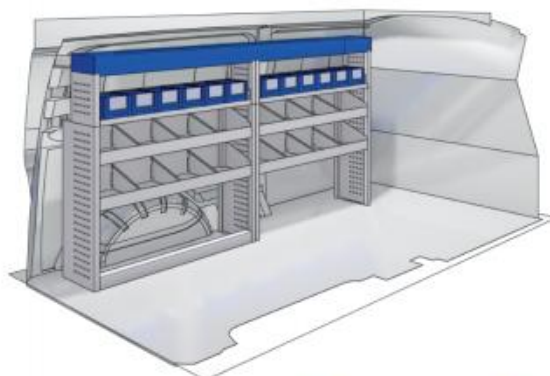

 2028mm
  1260mm
  360mm
  53kg

Silver Line

57-1-122-00

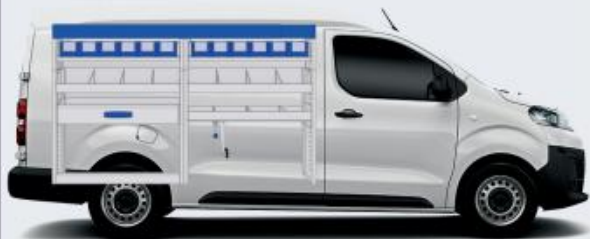

(wheel base: 3275mm)

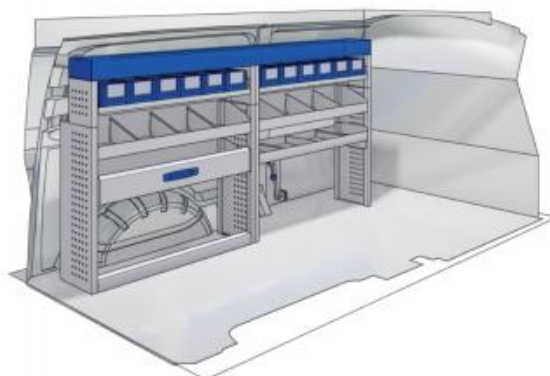

 2028mm
  1225mm
  360mm
  65kg

Gold Line

57-1-124-00

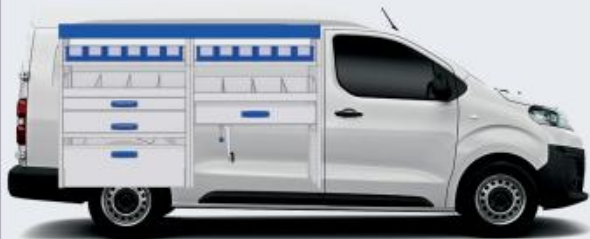

(wheel base: 3275mm)



 2028mm
  1260mm
  360mm
  78kg





**VAN CARE**



**VIVARO**

57-1-121-00

Bronze Line



(wheel base: 3275mm)

**L** 1267mm **D** 1085mm **D** 360mm **8** 48kg

RIGHT SIDE

57-1-123-00

Silver Line



(wheel base: 3275mm)

**L** 1267mm **D** 1085mm **D** 360mm **8** 66kg

57-1-105-00

Gold Line



(wheel base: 3275mm)

**L** 1267mm **D** 1085mm **D** 360mm **8** 63kg

# VIVARO



## VAN CARE

XLD LINE

Bronze Line

57-1-154-00



(wheel base: 2925mm)

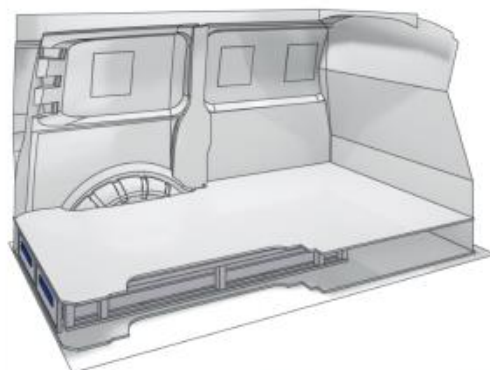

1526mm 176mm 1218mm 52kg

Silver Line

57-1-127-00



(wheel base: 2925mm)

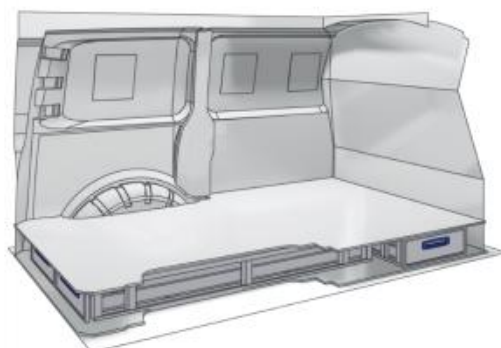

1992mm 176mm 1526mm 76kg

Gold Line

57-1-128-00



(wheel base: 2925mm)

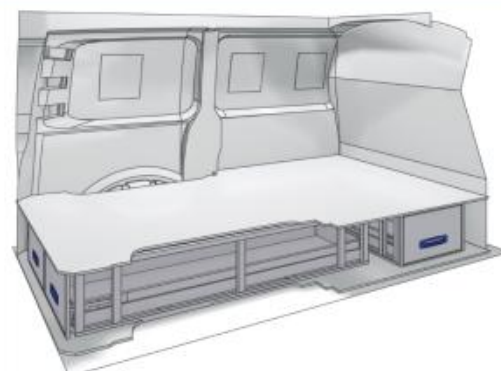

1992mm 310mm 1526mm 98kg



VAN CARE



VIVARO

57-1-154-00

Bronze Line

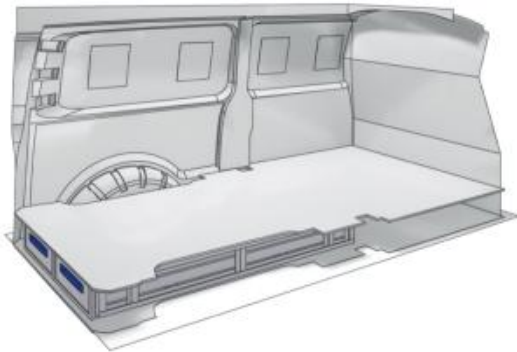

(wheel base: 3098mm)

 1526mm  176mm  1218mm  52kg

57-1-130-00

Silver Line

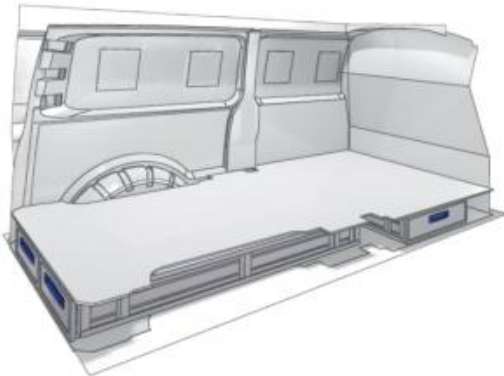

(wheel base: 3098mm)

 2135mm  176mm  1526mm  78kg

57-1-131-00

Gold Line

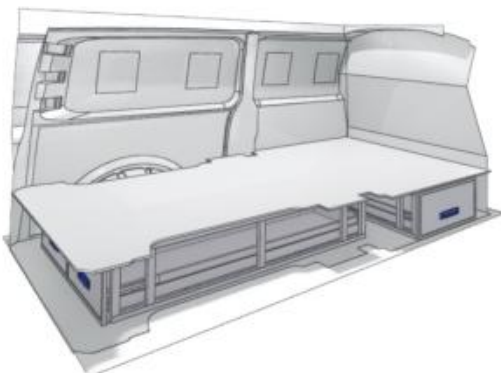

(wheel base: 3098mm)

 2135mm  310mm  1526mm  99kg



# MOVANO



# VAN CARE

LEFT SIDE

Bronze Line

57-1-133-00



(wheel base: 3000mm)

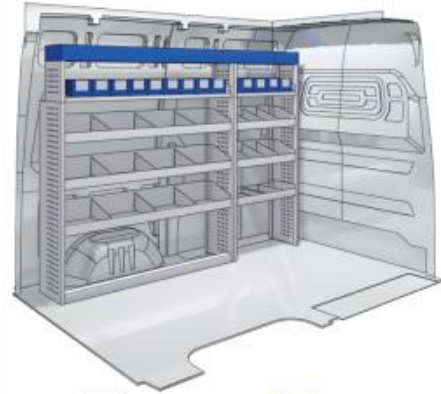

 2281mm  1750mm  360mm  73kg

Silver Line

57-1-135-00



(wheel base: 3000mm)

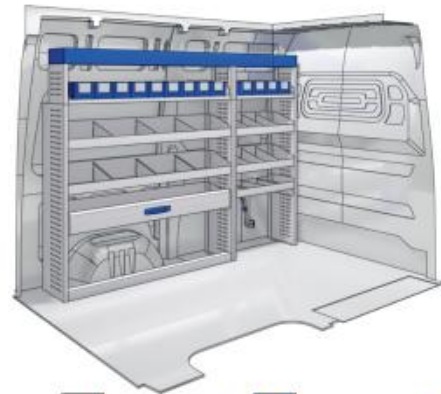

 2281mm  1750mm  360mm  83kg

Gold Line

57-1-136-00

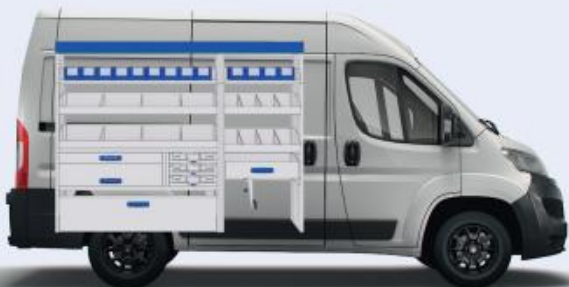

(wheel base: 3000mm)

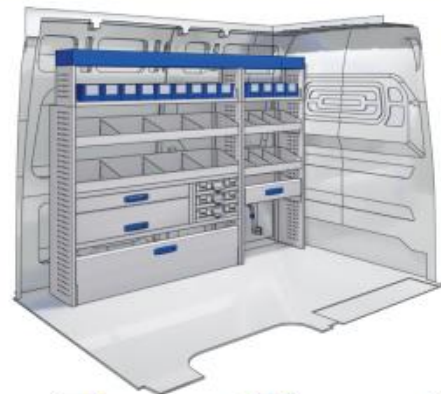

 2281mm  1750mm  360mm  120kg



**VAN CARE**



**MOVANO**

57-1-134-00

Bronze Line



1267mm 1750mm 360mm 60kg



(wheel base: 3000mm)

RIGHT SIDE

57-1-123-00

Silver Line



1267mm 1085mm 360mm 60kg



(wheel base: 3000mm)

57-1-105-00

Gold Line



1267mm 1085mm 360mm 63kg



(wheel base: 3000mm)

# MOVANO



# VAN CARE

LEFT SIDE

Bronze Line

57-1-137-00

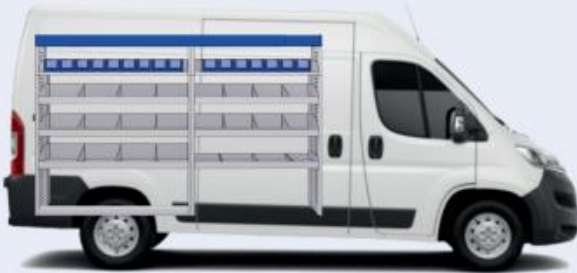

(wheel base: 3450mm)



2788mm 1750mm 360mm 80kg

Silver Line

57-1-135-00

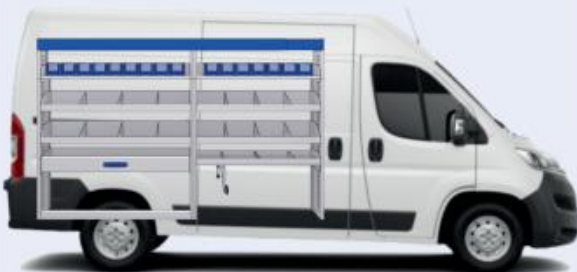

(wheel base: 3450mm)

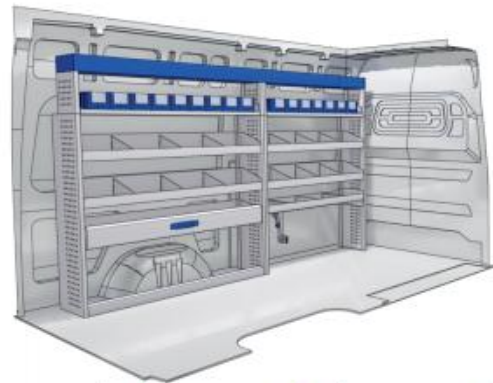

2788mm 1750mm 360mm 90kg

Gold Line

57-1-140-00

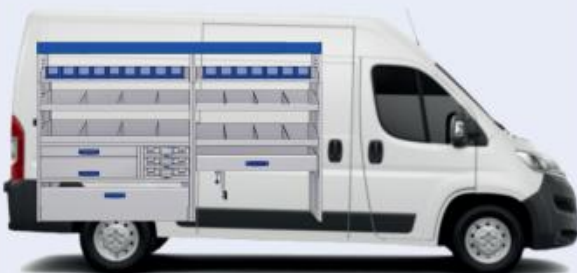

(wheel base: 3450mm)



2788mm 1750mm 360mm 130kg





**VAN CARE**



**MOVANO**

57-1-138-00

Bronze Line



**L** 1521mm **D** 1750mm **D** 360mm **B** 66kg



(wheel base: 3450mm)

RIGHT SIDE

57-1-123-00

Silver Line



**L** 1267mm **D** 1085mm **D** 360mm **B** 75kg



(wheel base: 3450mm)

57-1-105-00

Gold Line

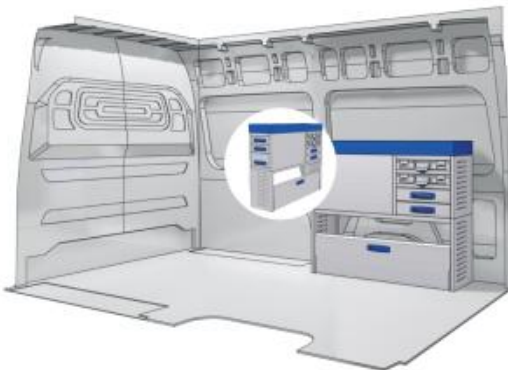

**L** 1267mm **D** 1085mm **D** 360mm **B** 63kg



(wheel base: 3450mm)



LEFT SIDE

### Bronze Line

57-1-142-00

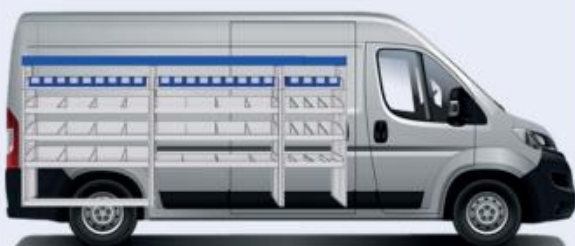

(wheel base: 4035mm)



3802mm 1750mm 360mm 110kg

### Silver Line

57-1-145-00

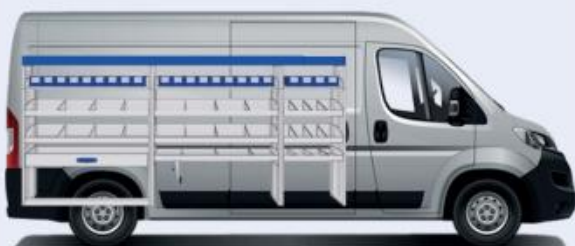

(wheel base: 4035mm)



3802mm 1750mm 360mm 120kg

### Gold Line

57-1-146-00



(wheel base: 4035mm)



3802mm 1750mm 360mm 160kg



VAN CARE



MOVANO

57-1-143-00

Bronze Line



2281mm 1750mm 360mm 108kg



(wheel base: 4035mm)

RIGHT SIDE

57-1-152-00

Silver Line

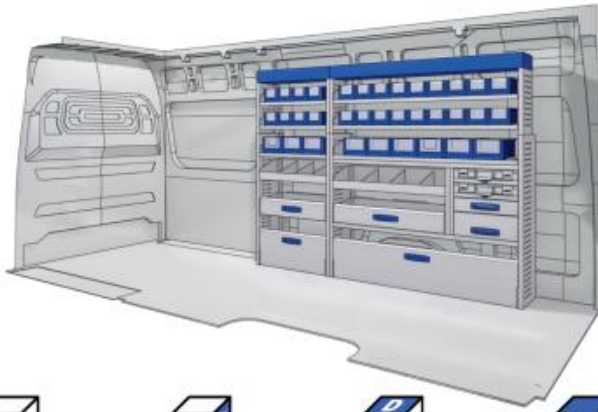

2281mm 1750mm 360mm 128kg



(wheel base: 4035mm)

57-1-153-00

Gold Line



2025mm 1750mm 360mm 143kg



(wheel base: 4035mm)





LEFT SIDE

### Bronze Line

57-1-142-00



(wheel base: 4035mm XL)

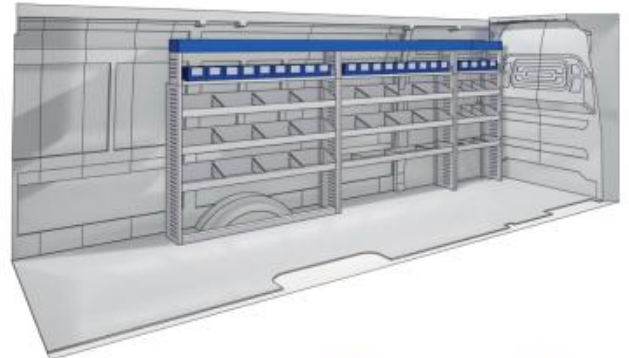

3802mm 1750mm 360mm 110kg

### Silver Line

57-1-145-00



(wheel base: 4035mm XL)

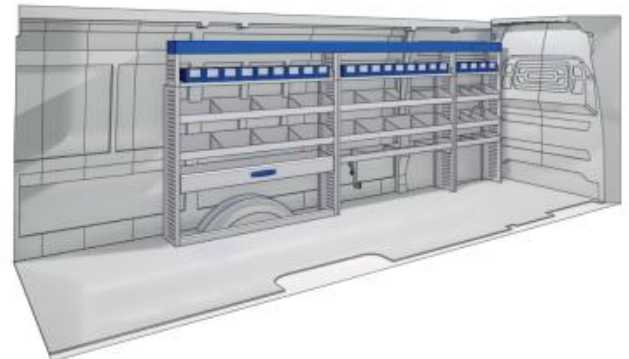

3802mm 1750mm 360mm 120kg

### Gold Line

57-1-146-00



(wheel base: 4035mm XL)

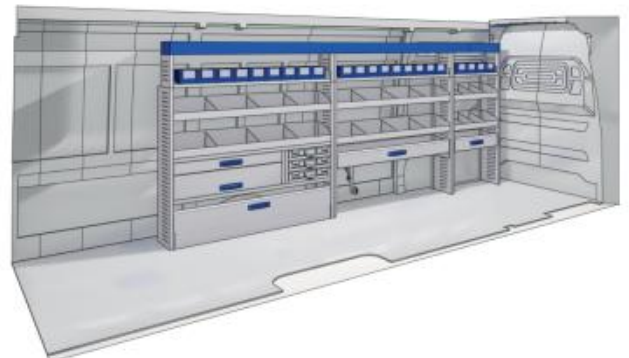

3802mm 1750mm 360mm 160kg



**VAN CARE**



**MOVANO**

57-1-147-00

Bronze Line

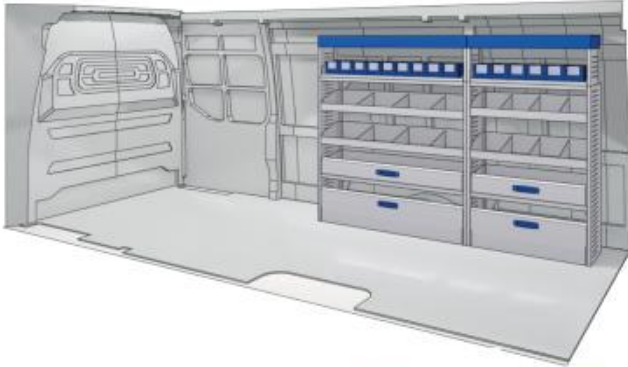

(wheel base: 4035mm XL)

2535mm 1750mm 360mm 120kg

57-1-152-00

Silver Line

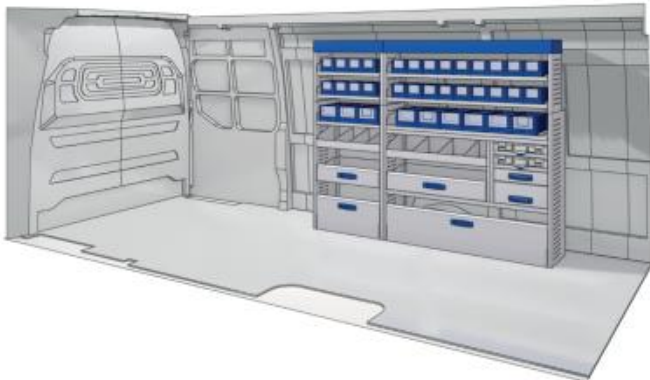

(wheel base: 4035mm XL)

2281mm 1750mm 360mm 128kg

57-1-153-00

Gold Line

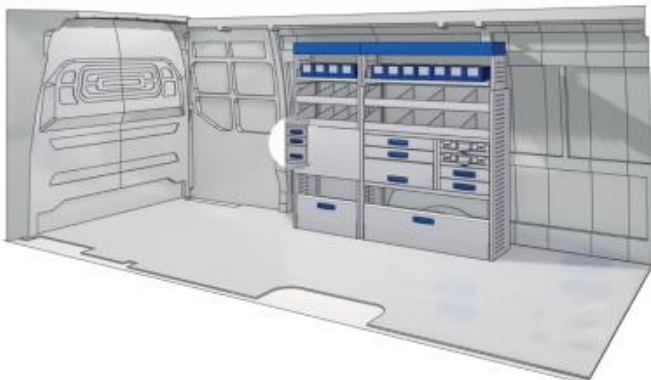

(wheel base: 4035mm XL)

2025mm 1085mm 360mm 143kg

RIGHT SIDE



Polychemstraat 14  
6191NL Beek (Limburg) Netherlands  
Phone number: +31 (0)46 4374147

